

“Yaşam Kalitesi İçin Üretir”

UNIVERSAL RETRACTOR SETS
UNIVERSAL EKARTÖR SETİ

TEKNO-CER
SURGICAL INSTRUMENTS MANUFACTURING INDUSTRY & T.C.L.

“Yaşam Kalitesi İçin Üretir”

All rights reserved.

No part of this catalog may be reproduced in any form
without the written permission from TEKNO-CER



PRODUCTS CATALOG 2023



GENEL ÜRETİM PROGRAMIMIZ

OUR GENERAL PRODUCTION PROGRAM

- GENEL CERRAHİ
- BEYİN CERRAHİ
- JİNEKOLOJİ
- ÜROLOJİ
- KALP DAMAR CERRAHİ
- KEMİK CERRAHİ
- KBB CERRAHİ
- PLASTİK CERRAHİ
- ÇENE CERRAHİ
- EL CERRAHİ
- MİKRO CERRAHİ
- GÖZ CERRAHİ
- STERİL KONTEYNER SİSTEMLERİ
- TİTANYUM ALETLER
- NAKİL EKARTÖRLERİ
- TEKNO-CER UNIVERSAL EKARTÖR
- LAPAROSKOPİK ALETLER
- GENERAL SURGERY
- NEUROSURGERY
- GYNECOLOGY
- UROLOGY
- CARDIO VASCULAR SURGERY
- BONE SURGERY
- ENT SURGERY
- PLASTIC SURGERY
- MAXILLO SURGERY
- HAND SURGERY
- MICRO SURGRY
- OPHTALMOLOGY
- STERILE CONTAINER SYSTEMS
- TITANIUM INSTRUMENTS
- TRANSPORT RETRACTORS
- TEKNO-CER UNIVERSAL RETRACTOR
- LAPAROSACOPIC INSTRUMENTS



SET ÖZELLİKLERİ

- Kolay kurulur,
- Operasyon sahasında rahat çalışma imkanı verir,
- Birçok operasyonda kullanılır,
- Geniş alet kullanım seçeneği sunar,
- Pozisyona göre kurulabilme avantajı sağlar,
- Asiste eleman sayısını azaltır.

SET OF FEATURES

- Easy to install,
- Allows convenient working regard to operation field,
- Can be used in various operations,
- It provides wide range of instrument usage,
- Provides use advantage depending on position,
- Reduces the number of staff-assisted.



• UNIVERSAL EKARTÖR SETİ

Tek taraflı masa bağlantılı çatı kurulumu

• UNIVERSAL RETRACTOR SETS

The installation of roof for single-sided operating table connection.



• UNIVERSAL EKARTÖR SETİ

İki taraflı masa bağlantılı çatı kurulumu

• UNIVERSAL RETRACTOR SETS

The installation of roof for double-sided operating table connection.

ÇATI ELEMANLARI

ROOF TOOLS



KOD **AÇIKLAMA**

TC 500.00 45cm
TC 500.01 50cm

Masa bağlantı ayağı / Tek bağlantılı
Rail clamp with cam joint

KOD **AÇIKLAMA**

TC 500.02 45cm
TC 500.03 50cm

Masa bağlantı ayağı / Çift bağlantılı
Rail clamp with two joints



KOD **AÇIKLAMA**

TC 500.04 50cm

Tek bağlantılı çatı mili
Cross bar with single cam joint



KOD **AÇIKLAMA**

TC 500.05 60cm

Çift bağlantılı çatı mili
Cross bar with 2 cam joints



KOD **AÇIKLAMA**

TC 500.06 13x15cm
TC 500.07 30x30cm
TC 500.08 20x40cm
TC 500.09 20x30cm
TC 500.10 25x25cm
TC 500.11 15x50cm

Açılı çatı mili
Angled cross bar



KOD **AÇIKLAMA**

TC 501.00 30x30cm

Katlanabilir tek eklemler çatı mili
Hinged extension arm



KOD **AÇIKLAMA**

TC 501.01 30cm
TC 501.02 40cm
TC 501.03 50cm

Düz çatı mili
Straight arm

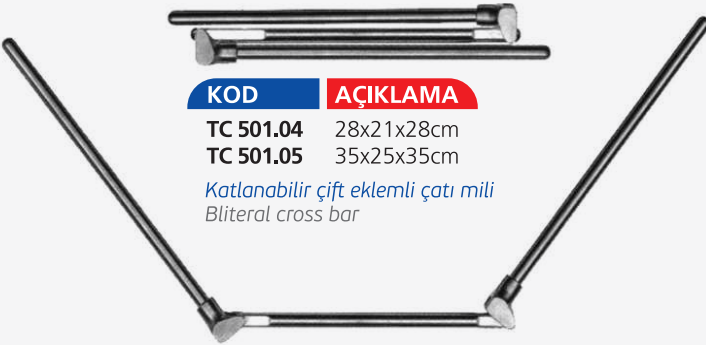

KOD **AÇIKLAMA**

TC 501.04 28x21x28cm
TC 501.05 35x25x35cm

Katlanabilir çift eklemler çatı mili
Bliteral cross bar



KOD **AÇIKLAMA**

TC 501.05A 50x50x30x30cm

Katlanabilir eklemler çatı mili
Bliteral cross bar

BAĞLANTI ELEMANLARI

CONECTION TOOLS



KOD **AÇIKLAMA**

TC 501.06 25cm
Ekartör Kolu / Açısı ayarlanabilir
Retractor arm, adjustable angle



KOD **AÇIKLAMA**

TC 501.10 -
Ekartör tutucu / Bükülebilir
Retractor holder flexible



KOD **AÇIKLAMA**

TC 501.07 25cm
Ekartör kolu, Bağlantı elemanı, Açısı ayarlanabilir
Retractor arm with cam joint adjustable angle



KOD **AÇIKLAMA**

TC 502.00 25cm
Ekartör kolu
Retractor arm

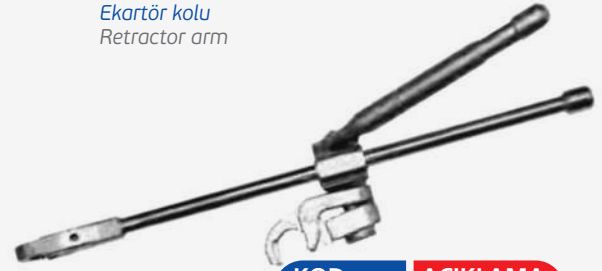

KOD **AÇIKLAMA**

TC 502.01 25cm
Ekartör kolu bağlantı elemanı
Retractor arm

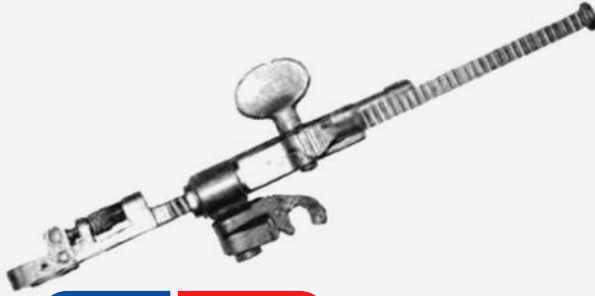

KOD **AÇIKLAMA**

TC 501.08 25,5cm
Ekartör kolu, Bağlantı elemanı, Açısı ayarlanabilir
Retractor arm with cam joint adjustable angle



KOD **AÇIKLAMA**

TC 502.02 25,5cm
Ekartör kolu bağlantı elemanı
Retractor arm with cam joint



Açısı ayarlanabilir ekartör kolu
Angle adjustable retractor arm



KOD **AÇIKLAMA**

TC 502.03 -
Işık taşıyıcı
Light carrier



KOD **TC 501.09**

TC 501.06 - TC 501.07 - TC 501.08
Açı değiştirme anahtarı ile kullanılır
Angle change tool



KOD **AÇIKLAMA**

TC 502.04 -
Çatı bağlantı elemanı
Cam frame joint



KOD **AÇIKLAMA**

TC 502.05 -
Ekartör bağlantı elemanı
Retractor cam joint



TC 900.00 MASAYA MONTE UNIVERSAL EKARTÖR SETİ

KOD **AÇIKLAMA**

A	TC 500.02 Masa bağlantı ayağı çift bağlantılı / 45cm	2 Adet
B	TC 502.01 Ekartör kolu bağlantı elemanlı / 25cm	2 Adet
C	TC 502.02 Ekartör kolu bağlantı elemanlı / 25,5cm	2 Adet
D	TC 501.04 Katlanabilir çift eklemlerli çatı mili / 28x21x28cm	1 Adet
E	TC 500.08 Açılı çatı mili cross bar / 20x40cm	2 Adet
F	TC 508.04 Balfour bleyt / 70x75mm	2 Adet
G	TC 508.06 Balfour bleyt / 80x75mm	1 Adet
H	TC 508.07 Balfour bleyt / 80x125mm	1 Adet
I	TC 505.00 Bükülebilir bleyt / 150mm	1 Adet
J	TC 502.07 Deaver bleyt / 40x125mm	2 Adet
K	TC 502.09 Deaver bleyt / 60x125mm	2 Adet
L	TC 503.11 Bükülebilir bleyt 50x100mm	2 Adet
M	TC 504.02 Harrington bleyt / 65x150mm	1 Adet
*	TK 110.15 Set konteynırı / 580x280x150mm	1 Adet
*	TK 191.10 Tel sepet / 540x255x100mm	1 Adet

TEKNO-CER MODEL EKARTÖR SETİ

TEKNO-CER MODEL RETRACTOR SETS

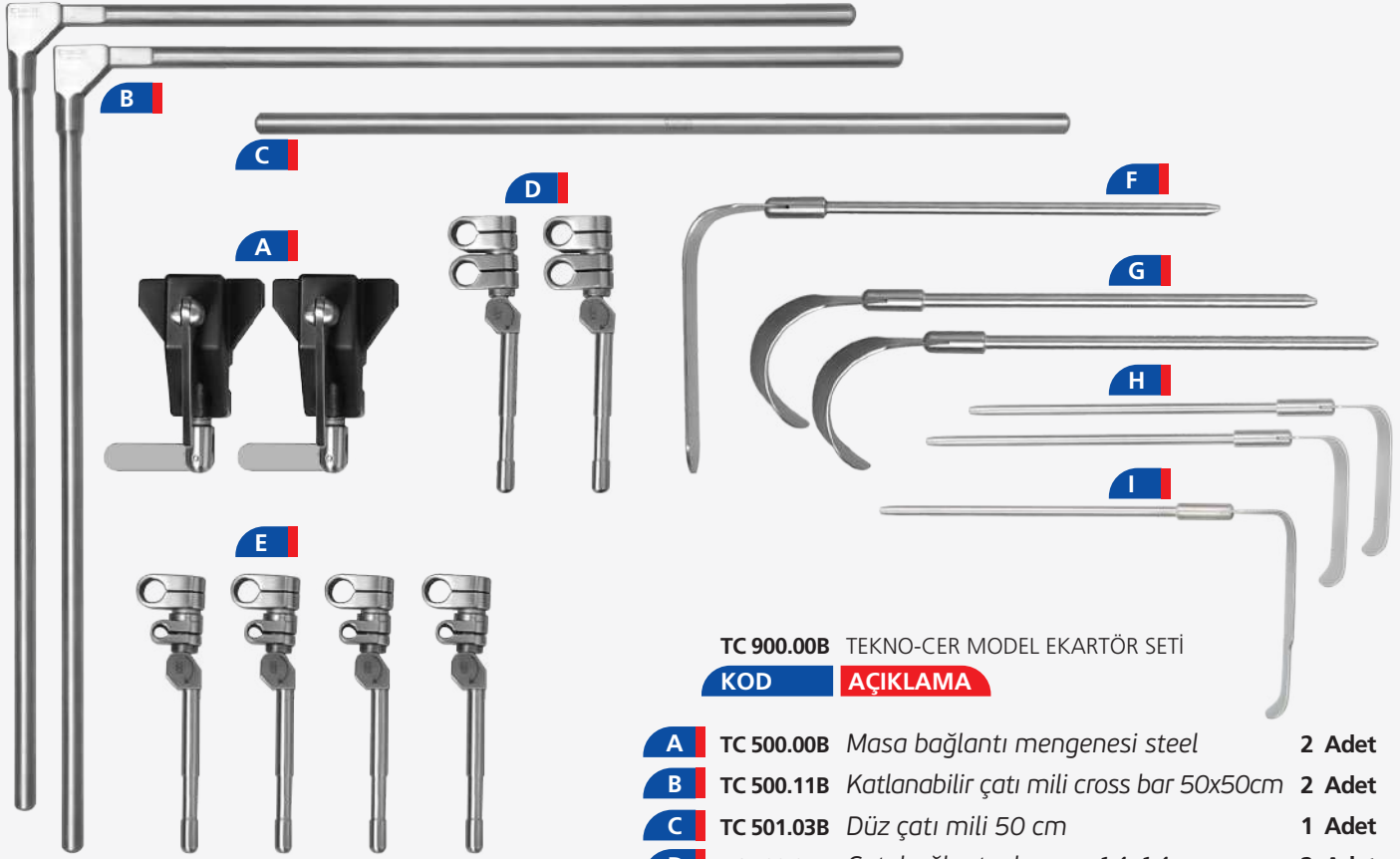

TC 900.00B TEKNO-CER MODEL EKARTÖR SETİ

KOD **AÇIKLAMA**

A	TC 500.00B Masa bağlantı mengenesi steel	2 Adet
B	TC 500.11B Katlanabilir çatı mili cross bar 50x50cm	2 Adet
C	TC 501.03B Düz çatı mili 50 cm	1 Adet
D	TC 502.04B Çatı bağlantı elemanı 14x14mm	2 Adet
E	TC 502.05B Ekartör bağlantı elemanı 8x14mm	4 Adet
F	TC 502.08B Deaver blade 50x150mm	1 Adet
G	TC 508.06B Balfour blade 80x75mm	2 Adet
H	TC 509.01B Richardson blade 50x100mm	2 Adet
I	TC 512.00B St. Marks Pelvis Ekartörü 65x140mm	1 Adet



GENEL TRANSPLANTASYON EKARTÖR SETİ
GENERAL TRANSPLANTATION RETRACTOR SET

TC 590.00

KOD **AÇIKLAMA**

Genel çatı / Tüm setlerde ortak kullanılabilir
General roof / Can be used in common

001	TC 500.02	Masa bağlantı ayağı çift bağlantılı / 45cm	2 Adet
002	TC 502.01	Ekartör kolu bağlantı elemanlı / 25cm	2 Adet
003	TC 502.02	Ekartör kolu bağlantı elemanlı / 25,5cm	2 Adet
004	TC 501.04	Katlanabilir çift eklemler çatı mili 28x21x28cm	1 Adet
005	TC 500.08	Açılı çatı mili cross bar / 20x40cm	2 Adet
006	TK 110.15	Konteynır / 580x280x150mm	1 Adet
007	TK 191.10	Tel sepet / 540x255x100mm	1 Adet

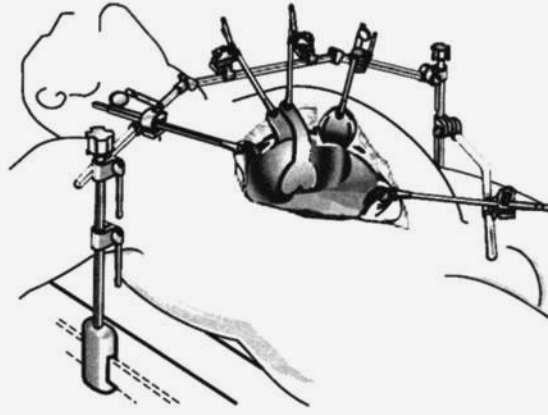

TC 590.01

KOD **AÇIKLAMA**

001	TC 503.01	Bükülebilir ekartör / 13x90mm	2 Adet
002	TC 503.02	Bükülebilir ekartör / 13x150mm	2 Adet
003	TC 503.03	Bükülebilir ekartör / 13x200mm	2 Adet
004	TC 503.04	Bükülebilir ekartör / 25x100mm	2 Adet
005	TC 503.05	Bükülebilir ekartör / 25x110mm	1 Adet
006	TC 503.11	Bükülebilir ekartör / 50x100mm	2 Adet
007	TC 503.14	Bükülebilir ekartör / 65x250mm	2 Adet
008	TC 503.15	Bükülebilir ekartör / 75x250mm	2 Adet
009	TC 503.16	Bükülebilir ekartör / 100x250mm	2 Adet
010	TC 511.02	Kelly ekartör / 60x70mm	1 Adet
011	TC 511.03	Kelly ekartör / 80x90mm	2 Adet
012	TC 508.04	Balfour ekartör / 70x75mm	2 Adet
013	TC 508.06	Balfour ekartör / 80x75mm	2 Adet
014	TC 508.00	Balfour ekartör / 30x30mm	4 Adet
015	TC 509.04	Richardson ekartör / 50x170mm	1 Adet
016	TC 504.02	Harrington ekartör / 65x150mm	1 Adet
017	TC 512.01	St.Marks pelvis ekartörü / 65x180mm	1 Adet
018	TC 505.00	Parmak ekartörü / 150mm	2 Adet
019	TC 508.05	Balfour ekartör 80x60mm	1 Adet
020	TC 508.09	Balfour ekartör 100x60mm	1 Adet
021	TC 508.07	Balfour ekartör 80x125mm	1 Adet
022	TC 502.07	Devaer ekartör / 40x125mm	2 Adet
023	TC 502.09	Deaver ekartör / 60x125mm	2 Adet

GENEL VASKÜLER / PEDIATRİK EKARTÖR SETİ**GENERAL VASCULAR / PEDIATRIC RETRACTOR SET****TC 590.02****KOD AÇIKLAMA**

001	TC 503.00	BÜKÜLEBİLİR EKARTÖR 13x65mm	2 Adet
002	TC 503.02	BÜKÜLEBİLİR EKARTÖR 13x150mm	2 Adet
003	TC 503.03	BÜKÜLEBİLİR EKARTÖR 13x200mm	2 Adet
004	TC 503.04	BÜKÜLEBİLİR EKARTÖR 25x100mm	2 Adet
005	TC 503.11	BÜKÜLEBİLİR EKARTÖR 50x100mm	2 Adet
006	TC 509.05	RICHARDSON EKARTÖR 20x25mm	1 Adet
007	TC 509.06	RICHARDSON EKARTÖR 20x50mm	1 Adet
008	TC 509.07	RICHARDSON EKARTÖR 25x30mm	1 Adet
009	TC 511.00	KELLY EKARTÖR 40x50mm	1 Adet
010	TC 511.02	KELLY EKARTÖR 60x70mm	1 Adet
011	TC 508.02	BALFOUR EKARTÖR 50x60mm	1 Adet
012	TC 508.00	BALFOUR EKARTÖR 30x30mm	2 Adet
013	TC 508.01	BALFOUR EKARTÖR 50x30mm	1 Adet
014	TC 509.01	RICHARDSON EKARTÖR 50x100mm	1 Adet
015	TC 504.00	HARRINGTON EKARTÖR 40x125mm	1 Adet
016	TC 502.06	DEAVER EKARTÖR 25x125mm	1 Adet

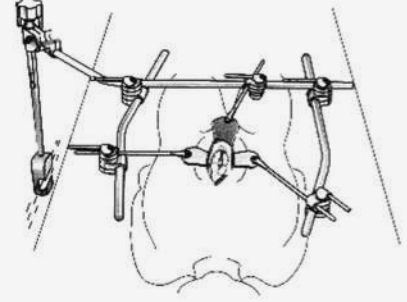
**TC 590.03****KOD AÇIKLAMA**

001	TC 503.07	BÜKÜLEBİLİR EKARTÖR 25x200mm	1 Adet
002	TC 506.00	DAMAR EKARTÖRÜ BÜKÜLEBİLİR 25x140mm	1 Adet
003	TC 503.12	BÜKÜLEBİLİR EKARTÖR 50x200mm	2 Adet
004	TC 503.14	BUKULEBİLİR EKARTÖR 65x250mm	1 Adet
005	TC 503.15	BUKULEBİLİR EKARTÖR 75x250mm	1 Adet
006	TC 509.05	RICHARDSON EKARTÖR 20x25mm	1 Adet
007	TC 511.03	KELLY EKARTÖR 80x90mm	1 Adet
008	TC 510.02	FENCE EKARTÖR 100x100mm	1 Adet
009	TC 510.03	FENCE EKARTÖR 100x125mm	1 Adet
010	TC 510.04	FENCE EKARTÖR 100x150mm	1 Adet
011	TC 508.03	BALFOUR EKARTÖR 70x50mm	1 Adet
012	TC 508.04	BALFOUR EKARTÖR 70x75mm	1 Adet
013	TC 508.10	BALFOUR EKARTÖR 90mm	2 Adet
014	TC 509.02	RICHARDSON EKARTÖR 50x125mm	2 Adet
015	TC 504.02	HARRINGTON EKARTÖR 65x150mm	1 Adet
016	TC 502.08	DEAVER EKARTÖR 50x125mm	1 Adet
017	TC 512.01	ST. MARKS PELVİS EKARTÖRÜ 65x180mm	1 Adet
018	TC 505.00	PARMAK EKARTÖR 150mm	1 Adet
019	TC 508.04	BALFOUR EKARTÖR 70x75mm	1 Adet
020	TC 508.08	BALFOUR EKARTÖR 90x150mm	1 Adet

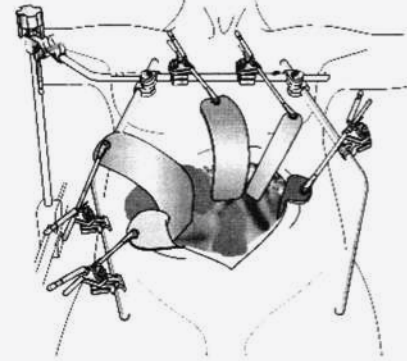
**TC 590.04****KOD AÇIKLAMA**

001	TC 508.10	BALFOUR EKARTÖR 90mm	2 Adet
002	TC 502.06	DEAVER EKARTÖR 25x125mm	2 Adet
003	TC 517.01	HILL-FERGUSON REKTUM EKARTÖRÜ 30x75mm	1 Adet
004	TC 517.00	HILL-FERGUSON REKTUM EKARTÖRÜ 25x65mm	1 Adet
005	TC 512.01	ST. MARKS PELVİS EKARTÖRÜ 65x180mm	1 Adet

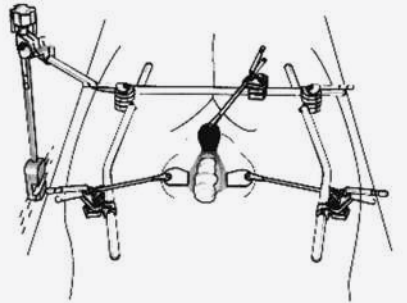

ABDOMİNAL / VASKÜLER EKARTÖRLER

ABDOMINAL / VASCULAR RETRACTORS

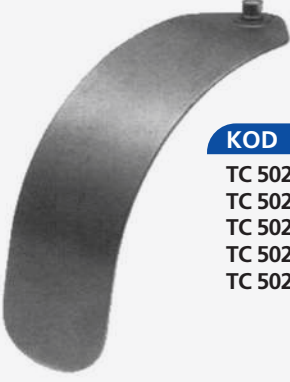

DEAVER

KOD	AÇIKLAMA
TC 502.06	25x125mm
TC 502.07	40x125mm
TC 502.08	50x125mm
TC 502.09	60x125mm
TC 502.10	80x125mm



KOD	AÇIKLAMA
TC 503.00	13x65mm
TC 503.01	13x90mm
TC 503.02	13x150mm
TC 503.03	13x200mm
TC 503.04	25x100mm
TC 503.05	25x110mm
TC 503.06	25x130mm
TC 503.07	25x200mm
TC 503.08	25x250mm
TC 503.09	40x200mm
TC 503.10	40x250mm
TC 503.11	50x100mm
TC 503.12	50x200mm
TC 503.13	50x250mm
TC 503.14	65x250mm
TC 503.15	75x250mm
TC 503.16	100x250mm
TC 503.17	65x150mm

*Bükülebilir
Flexible*

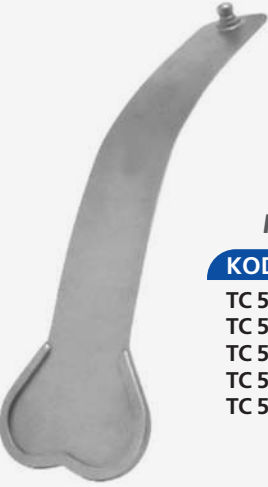

HARRINGTON

KOD	AÇIKLAMA
TC 504.00	40x125mm
TC 504.01	65x100mm
TC 504.02	65x150mm
TC 504.03	65x200mm
TC 504.04	65x250mm



KOD	AÇIKLAMA
TC 505.00	150mm

*Bükülebilir
Flexible*



KOD	AÇIKLAMA
TC 506.00	25x140mm
TC 506.01	25x200mm

*Damar ekartörü / Bükülebilir
Vascular retractor flexible*



KOD	AÇIKLAMA
TC 507.00	25x140mm
TC 507.01	25x200mm

*Damar ekartörü
Vascular retractor*

ABDOMİNAL / VASKÜLER / JİNEKOLOJİ / KOLON EKARTÖR BLEYTLER**ABDOMINAL / VASCULAR / GYNECOLOGY / COLON RETRACTORS****BALFOUR**

KOD	AÇIKLAMA
TC 508.00	30x30mm
TC 508.01	50x30mm
TC 508.02	50x60mm
TC 508.03	70x50mm
TC 508.04	70x75mm
TC 508.05	80x60mm
TC 508.06	80x75mm
TC 508.07	80x125mm
TC 508.08	90x150mm
TC 508.09	100x60mm

**BALFOUR**

KOD	AÇIKLAMA
TC 508.10	90mm
TC 508.11	130mm

**RICHARDSON**

KOD	AÇIKLAMA
TC 509.00	50x75mm
TC 509.01	50x100mm
TC 509.02	50x125mm
TC 509.03	50x150mm
TC 509.04	50x170mm

**RICHARDSON**

KOD	AÇIKLAMA
TC 509.05	20x25mm
TC 509.06	20x50mm
TC 509.07	25x30mm
TC 509.08	45x50mm

**FENCE**

KOD	AÇIKLAMA
TC 510.00	50x110mm
TC 510.01	50x150mm
TC 510.02	100x100mm
TC 510.03	100x125mm
TC 510.04	100x150mm
TC 510.05	100x200mm

**KELLY**

KOD	AÇIKLAMA
TC 511.00	40x50mm
TC 511.01	50x60mm
TC 511.02	60x70mm
TC 511.03	80x90mm

**ST.MARKS**

KOD	AÇIKLAMA
TC 512.00	65x140mm
TC 512.01	65x180mm

Pelvis ekartörü
Pelvis retractor

**HEANY**

KOD	AÇIKLAMA
TC 513.00	25x100mm
TC 513.01	25x130mm

ABDOMİNAL / REKTAL / UROLOJİ EKARTÖR BLEYTLER

ABDOMİNAL / RECTAL / URULOGY / RETCACTOR BLADES



KOD **AÇIKLAMA**

TC 514.00	13x70mm
TC 514.01	13x75mm
TC 514.02	25x65mm
TC 514.03	25x75mm

Mesane ekartörü
Bladder retractor



KOD **AÇIKLAMA**

TC 514.04	25x65mm
-----------	---------

Mesane ekartörü
Bladder retractor



KOD **AÇIKLAMA**

TC 514.05	80x130mm
-----------	----------



HOLTGREWE

KOD **AÇIKLAMA**

TC 515.00	60x150mm
-----------	----------

MURPHY



KOD **AÇIKLAMA**

TC 516.00	19x13mm Sivri/Sharp
TC 516.01	19x13mm Künt/Blunt
TC 516.02	25x13mm Sivri/Sharp
TC 516.03	25x13mm Künt/Blunt

Cilt ekartörü
Skin retractor

VOLKMAN



KOD **AÇIKLAMA**

TC 516.04	16x13mm Sivri/Sharp
TC 516.05	16x13mm Künt/Blunt
TC 516.06	25x13mm Sivri/Sharp
TC 516.07	25x13mm Künt/Blunt

Cilt ekartörü
Skin retractor



HILL-FERGUSON

KOD **AÇIKLAMA**

TC 517.00	25x65mm
TC 517.01	30x75mm

Rektum ekartörü
Rectum retractor



HARRIS

KOD **AÇIKLAMA**

TC 518.00	-
-----------	---

Prostat ekartörü
Prostate retractor

SPİNAL / SERVİKAL / LUMBAR EKARTÖR BLEYTLER

SPINAL / CERVICAL / LUMBAR RETRACTOR BLADES

MEYERDING



KOD	AÇIKLAMA
TC 519.00	16x50mm
TC 519.01	16x75mm
TC 519.02	16x100mm
TC 519.03	25x50mm
TC 519.04	25x75mm
TC 519.05	25x100mm

MEYERDING



KOD	AÇIKLAMA
TC 519.06	16x50mm
TC 519.07	16x75mm
TC 519.08	16x100mm
TC 519.09	25x50mm
TC 519.10	25x75mm
TC 519.11	25x100mm

MEYERDING



KOD	AÇIKLAMA
TC 520.00	16x40mm
TC 520.01	16x45mm
TC 520.02	16x50mm
TC 520.03	16x55mm
TC 520.04	16x60mm

MEYERDING



KOD	AÇIKLAMA
TC 520.05	20x80mm
TC 520.06	45x80mm
TC 520.07	60x80mm
TC 520.08	20x100mm
TC 520.09	45x100mm
TC 520.10	60x100mm
TC 520.11	20x120mm
TC 520.12	45x120mm
TC 520.13	60x120mm

MEYERDING



KOD	AÇIKLAMA
TC 521.00	16x40mm
TC 521.01	16x45mm
TC 521.02	16x50mm
TC 521.03	16x55mm
TC 521.04	16x60mm

SCOVILLE



KOD	AÇIKLAMA
TC 522.00	75mm
TC 522.01	100mm

KOD AÇIKLAMA



KOD	AÇIKLAMA
TC 523.00	20x55mm
TC 523.01	25x30mm
TC 523.02	25x40mm
TC 523.03	25x50mm
TC 523.04	25x60mm
TC 523.05	25x70mm
TC 523.06	25x80mm

*Lumbar ekartör / Eğri uçlu
Lumbar retractor / Curved*

KOD AÇIKLAMA



KOD	AÇIKLAMA
TC 523.07	13x50mm
TC 523.08	13x75mm
TC 523.09	13x100mm
TC 523.10	19x50mm
TC 523.11	19x75mm
TC 523.12	19x100mm
TC 523.13	50x25mm
TC 523.14	75x25mm
TC 523.15	25x100mm

*Lumbar ekartör / Düz uçlu
Lumbar retractor / Straight*

KOD AÇIKLAMA

KOD	AÇIKLAMA
TC 524.01	90° Root ekartörü Root retractor

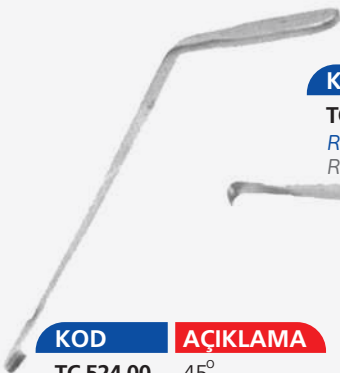

KOD	AÇIKLAMA
TC 524.00	45° Root ekartörü Root retractor

KOD AÇIKLAMA

KOD	AÇIKLAMA
TC 525.00	25x100mm
TC 525.01	25x150mm
TC 525.02	25x200mm
TC 525.03	25x250mm
TC 525.04	30x100mm
TC 525.05	30x150mm
TC 525.06	30x200mm
TC 525.07	30x250mm

*Anterior lumbar ekartör / Tırnaklı
Anterior lumbar retractor / With nail*

TC 590.05

KOD **AÇIKLAMA**

001	TC 503.07	BÜKÜLEBİLİR EKARTÖR 25x200mm	2 Adet
002	TC 503.12	BÜKÜLEBİLİR EKARTÖR 50x200mm	2 Adet
003	TC 503.14	BÜKÜLEBİLİR EKARTÖR 65x250mm	2 Adet
004	TC 503.15	BÜKÜLEBİLİR EKARTÖR 75x250mm	2 Adet
005	TC 509.05	RICHARDSON EKARTÖR 20x25mm	1 Adet
006	TC 509.06	RICHARDSON EKARTÖR 20x50mm	1 Adet
007	TC 509.07	RICHARDSON EKARTÖR 25x30mm	1 Adet
008	TC 511.00	KELLY EKARTÖR 40x50mm	1 Adet
009	TC 511.01	KELLY EKARTÖR 50x60mm	1 Adet
010	TC 511.02	KELLY EKARTÖR 60x70mm	1 Adet
011	TC 508.02	BALFOUR EKARTÖR 50x60mm	2 Adet
012	TC 508.01	BALFOUR EKARTÖR 50x30mm	2 Adet
013	TC 509.01	RICHARDSON EKARTÖR 50x100mm	1 Adet
014	TC 509.02	RICHARDSON EKARTÖR 50x125mm	1 Adet
015	TC 504.02	HARRINGTON EKARTÖR 65x150mm	1 Adet

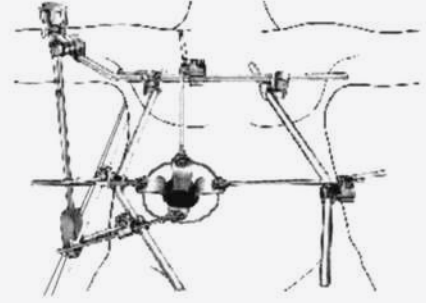

TC 590.06

KOD **AÇIKLAMA**

001	TC 518.00	HARRIS PROSTAT EKARTÖRÜ	1 Adet
002	TC 514.03	MESANE EKARTÖRÜ 25x75mm	2 Adet
003	TC 514.02	MESANE EKARTÖRÜ 25x65mm	2 Adet
004	TC 514.01	MESANE EKARTÖRÜ 13x75mm	2 Adet
005	TC 514.00	MESANE EKARTÖRÜ 13x70mm	2 Adet
006	TC 514.04	MESANE EKARTÖRÜ 25x65mm	1 Adet
007	TC 516.00	MURPHY CİLT EKARTÖRÜ KUNT 25x13mm	1 Adet
008	TC 503.02	BUKULEBİLİR EKARTÖR 13x150mm	1 Adet
009	TC 503.12	BUKULEBİLİR EKARTÖR 50x200mm	1 Adet
010	TC 503.09	BUKULEBİLİR EKARTÖR 40x200mm	1 Adet

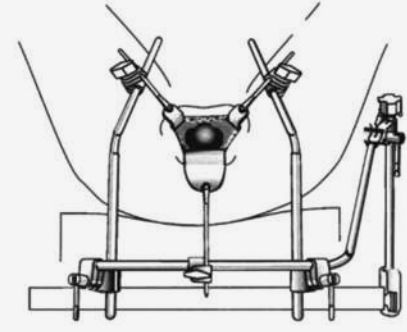

TC 590.07

KOD **AÇIKLAMA**

001	TC 503.12	BÜKÜLEBİLİR EKARTÖR 50x200mm	1 Adet
002	TC 503.14	BÜKÜLEBİLİR EKARTÖR 65x250mm	1 Adet
003	TC 511.02	KELLY EKARTÖR 60x70mm	1 Adet
004	TC 511.03	KELLY EKARTÖR 80x90mm	1 Adet
005	TC 510.04	FENCE EKARTÖR 100x150mm	1 Adet
006	TC 508.03	BALFOUR EKARTÖR 70x50mm	2 Adet
007	TC 509.02	RICHARDSON EKARTÖR 50x125mm	1 Adet
008	TC 504.02	HARRINGTON EKARTÖR 65x150mm	1 Adet
009	TC 502.08	DEAVER EKARTÖR 50x125mm	1 Adet

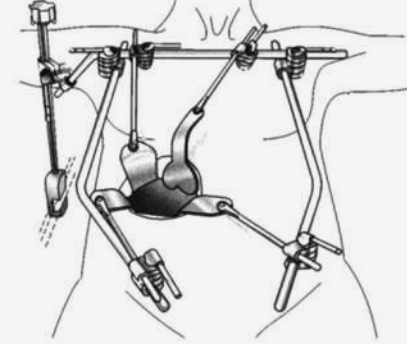

TC 590.08

KOD **AÇIKLAMA**

001	TC 503.12	BÜKÜLEBİLİR EKARTÖR 50x200mm	1 Adet
002	TC 503.14	BÜKÜLEBİLİR EKARTÖR 65x250mm	1 Adet
003	TC 511.03	KELLY EKARTÖR 80x90mm	2 Adet
004	TC 510.04	FENCE EKARTÖR 100x150mm	1 Adet
005	TC 515.00	HOLTGREVE EKARTÖR 60x150mm	1 Adet
006	TC 508.02	BALFOUR EKARTÖR 50x60mm	2 Adet
007	TC 508.01	BALFOUR EKARTÖR 30x50mm	2 Adet
008	TC 508.10	BALFOUR EKARTÖR 90mm	2 Adet
009	TC 509.02	RICHARDSON EKARTÖR 50x125mm	1 Adet
010	TC 504.02	HARRINGTON EKARTÖR 65x150mm	1 Adet
011	TC 504.03	HARRINGTON EKARTÖR 65x200mm	1 Adet
012	TC 502.06	DEAVER EKARTÖR 25x125mm	1 Adet

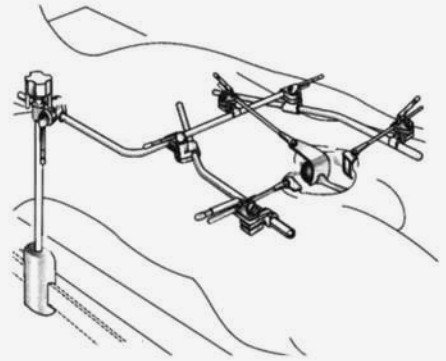

SPINAL / LUMBAR EKARTÖR SETİ

SPINAL / LUMBAR RETRACTOR SETS

TC 590.09

KOD	AÇIKLAMA	
001	TC 506.00 DAMAR EKARTÖRÜ BÜKÜLEBİLİR 25x140mm	2 Adet
002	TC 506.01 DAMAR EKARTÖRÜ BÜKÜLEBİLİR 25x200mm	2 Adet
003	TC 507.00 DAMAR EKARTÖRÜ BÜKÜLEBİLİR 25x140mm	2 Adet
004	TC 507.01 DAMAR EKARTÖRÜ BÜKÜLEBİLİR 25x200mm	2 Adet
005	TC 525.00 ANTERIOR LUMBAR EKARTÖR TIRNAKLI 25x100mm	2 Adet
006	TC 525.01 ANTERIOR LUMBAR EKARTÖR TIRNAKLI 25x150mm	2 Adet
007	TC 525.02 ANTERIOR LUMBAR EKARTÖR TIRNAKLI 25x200mm	2 Adet
008	TC 525.04 ANTERIOR LUMBAR EKARTÖR TIRNAKLI 30x100mm	2 Adet
009	TC 525.05 ANTERIOR LUMBAR EKARTÖR TIRNAKLI 30x150mm	2 Adet
010	TC 525.06 ANTERIOR LUMBAR EKARTÖR TIRNAKLI 30x200mm	2 Adet
011	TC 525.07 ANTERIOR LUMBAR EKARTÖR TIRNAKLI 30x250mm	2 Adet
012	TC 525.03 ANTERIOR LUMBAR EKARTÖR TIRNAKLI 25x250mm	2 Adet

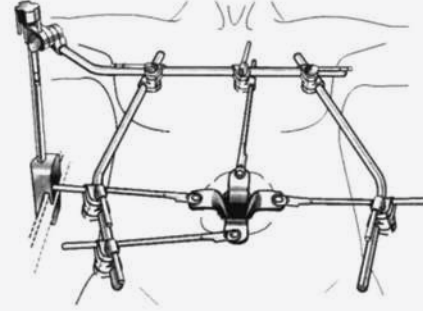

TC 590.10

KOD	AÇIKLAMA	
001	TC 520.05 ÇİFT AÇILI LAMİNEKTOMİ EKARTÖR 20x80mm	2 Adet
002	TC 520.06 ÇİFT AÇILI LAMİNEKTOMİ EKARTÖR 45x80mm	2 Adet
003	TC 520.07 ÇİFT AÇILI LAMİNEKTOMİ EKARTÖR 60x80mm	2 Adet
004	TC 520.08 ÇİFT AÇILI LAMİNEKTOMİ EKARTÖR 20x100mm	2 Adet
005	TC 520.09 ÇİFT AÇILI LAMİNEKTOMİ EKARTÖR 45x100mm	2 Adet
006	TC 520.10 ÇİFT AÇILI LAMİNEKTOMİ EKARTÖR 60x100mm	2 Adet
007	TC 520.11 ÇİFT AÇILI LAMİNEKTOMİ EKARTÖR 20x120mm	2 Adet
008	TC 520.12 ÇİFT AÇILI LAMİNEKTOMİ EKARTÖR 45x120mm	2 Adet
009	TC 520.13 ÇİFT AÇILI LAMİNEKTOMİ EKARTÖR 60x120mm	2 Adet
010	TC 519.08 MEYERDİNG LAMİNE EKARTÖR DIŞSİZ 16x100mm	2 Adet
011	TC 519.10 MEYERDİNG LAMİNE EKARTÖR DIŞSİZ 25x75mm	2 Adet
012	TC 519.11 MEYERDİNG LAMİNE EKARTÖR DIŞSİZ 25x100mm	2 Adet
013	TC 519.02 MEYERDİNG LAMİNE EKARTÖR DIŞSİZ 16x100mm	2 Adet
014	TC 519.04 MEYERDİNG LAMİNE EKARTÖR DIŞSİZ 25x75mm	2 Adet
015	TC 519.05 MEYERDİNG LAMİNE EKARTÖR DIŞSİZ 25x100mm	2 Adet
016	TC 524.01 ROOT EKARTÖRÜ 90°	2 Adet
017	TC 524.00 ROOT EKARTÖRÜ 45°	1 Adet

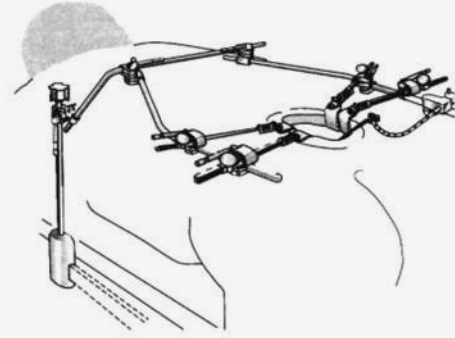

TC 590.11

KOD	AÇIKLAMA	
001	TC 521.00 SPİNAL EKARTÖR DIŞSİZ 16x40mm	1 Adet
002	TC 521.01 SPİNAL EKARTÖR DIŞSİZ 16x45mm	1 Adet
003	TC 521.02 SPİNAL EKARTÖR DIŞSİZ 16x50mm	1 Adet
004	TC 521.03 SPİNAL EKARTÖR DIŞSİZ 16x55mm	1 Adet
005	TC 521.04 SPİNAL EKARTÖR DIŞSİZ 16x60mm	1 Adet
006	TC 520.00 SPİNAL EKARTÖR DIŞLİ 16x40mm	1 Adet
007	TC 520.01 SPİNAL EKARTÖR DIŞLİ 16x45mm	1 Adet
008	TC 520.02 SPİNAL EKARTÖR DIŞLİ 16x50mm	2 Adet
009	TC 520.03 SPİNAL EKARTÖR DIŞLİ 16x55mm	2 Adet
010	TC 520.04 SPİNAL EKARTÖR DIŞLİ 16x60mm	2 Adet
011	TC 523.00 EKARTÖR EĞRİ UÇLU 20x55mm	2 Adet
012	TC 523.01 EKARTÖR EĞRİ UÇLU 25x30mm	2 Adet
013	TC 523.02 EKARTÖR EĞRİ UÇLU 25x40mm	2 Adet
014	TC 523.04 EKARTÖR EĞRİ UÇLU 25x60mm	2 Adet
015	TC 523.06 EKARTÖR EĞRİ UÇLU 25x80mm	2 Adet

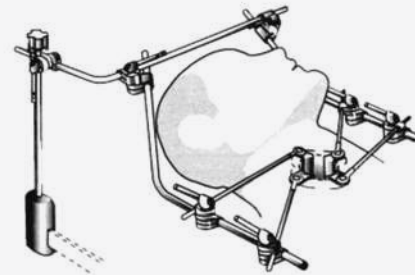

ORGAN NAKLİ EL ALETLERİ

TRANSPLANTASYON SURGICAL INSTRUMENTS



KOD

CALNE 27 cm TC 425.26 / TC 425.27
Atraumatic TC 425.28

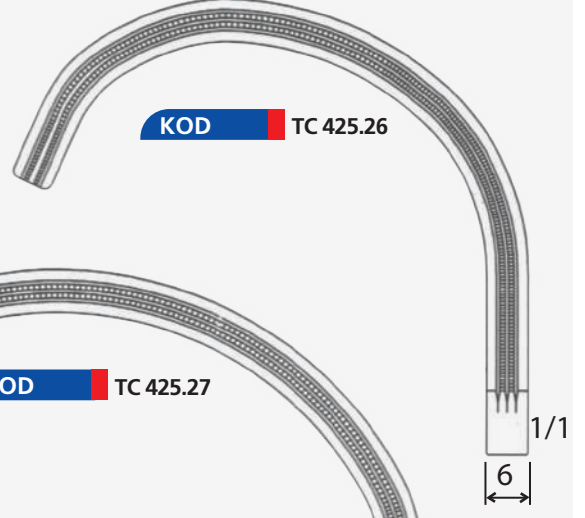

KOD TC 425.26

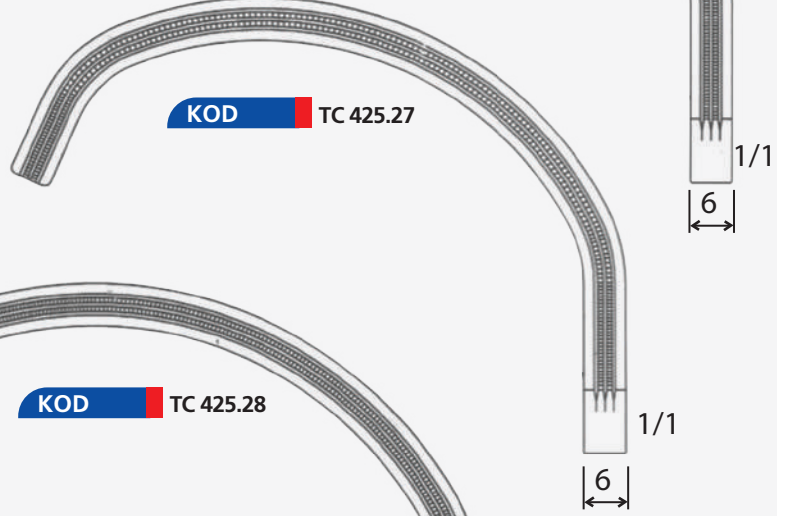

KOD TC 425.27

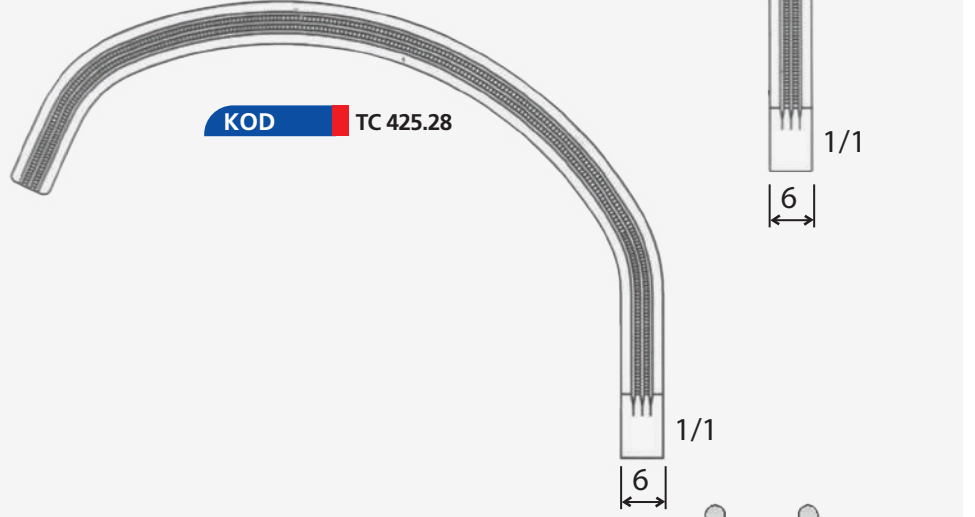

KOD TC 425.28

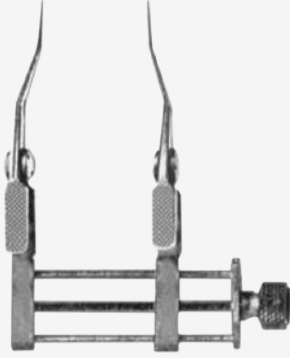

KOD T15-042

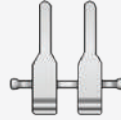

KOD T15-024

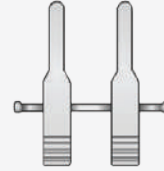

KOD T15-025

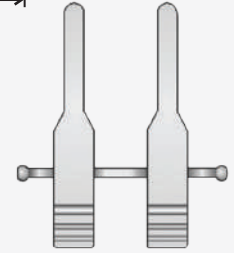

KOD T15-026



KOD T15-027



KOD T15-028



KOD T15-029



KOD T15-030



KOD T15-031



KOD T15-032

STERILE CONTAINER SYSTEM



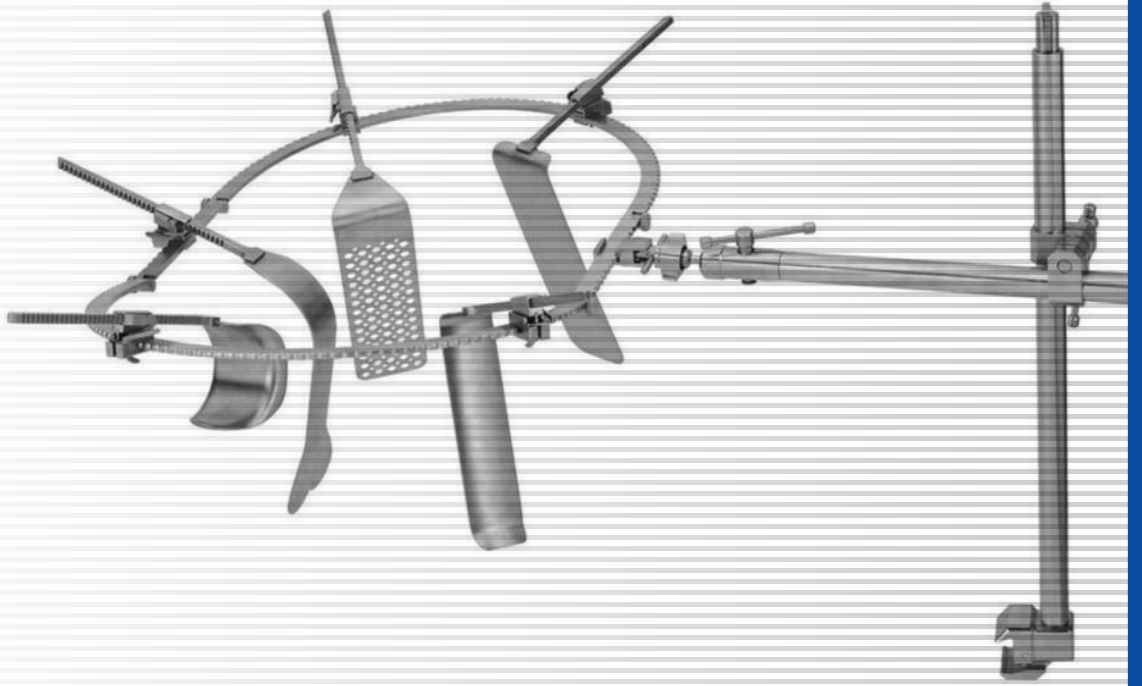

“Yaşam Kalitesi İçin Üretir”

BOOKWALTER RETRACTOR SET
BOOKWALTER EKARTÖR SETİ

TC 560.00 Masa bağlantı direği
48 cm
TC 560.01 Masa bağlantı direği
58 cm

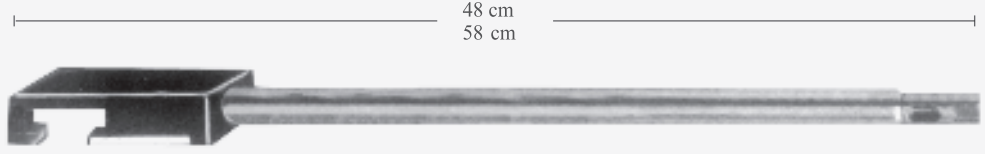

TC 561.00
Çember tutucu
36.5 cm



TC 561.01
360° Çember tutucu, hareketli



TC 561.02
Yatay çubuk 30.5 cm



TC 561.03
Bağlantı elmanı

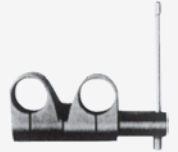

TC 562.00
Ekartör uzatma kolu

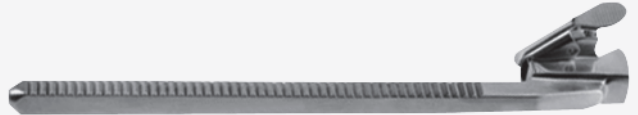

TC 562.01
Ekartör bağlantı elmanı
Dönebilir



TC 562.02
Ekartör bağlantı elmanı
Sabit



TC 562.03
Ekartör bağlantı elmanı
Değişebilir açılı

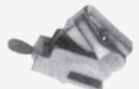

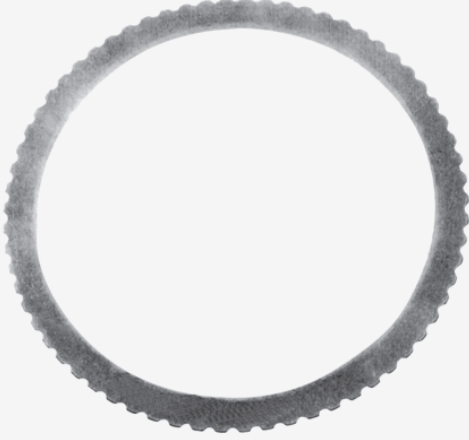

TC 563.00 Küçük Ø 215 mm
TC 563.01 Orta Ø 265 mm
TC 563.02 Büyük Ø 315 mm
Yuvarlak çember



TC 563.04 Küçük 200 x 310 mm
TC 563.05 Orta 265 x 370 mm
TC 563.06 Büyük 265 x 470 mm
Oval çember

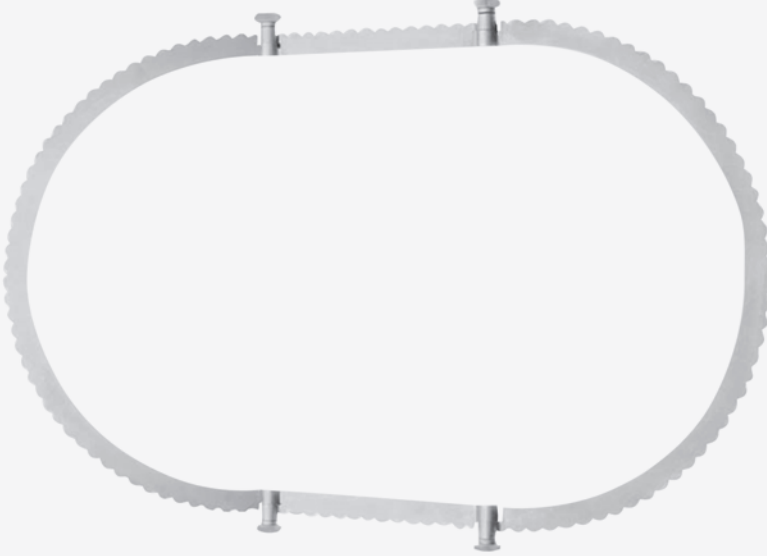

TC 563.07 Küçük 215 x 355 mm
TC 563.08 Orta 265 x 495 mm
TC 563.09 Büyük 315 x 495 mm
TC 563.10 Geniş 405 x 595 mm
Parçalı oval çember

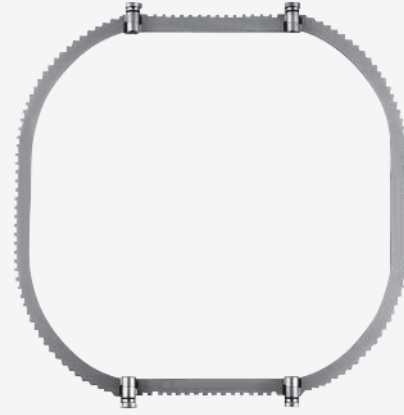

TC 563.11 380 x 368 mm
Parçalı çember



TC 563.12
Katlanır çember 200 x 265 mm

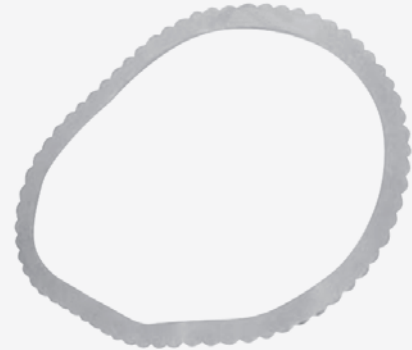

TC 563.14
Oval çember 200 x 265 mm

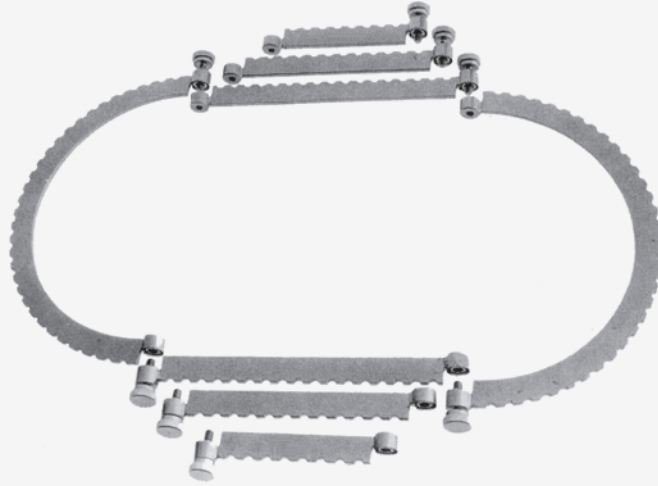

Spinal cerrahi ekartörü

TC 563.15 Yarım çember 203 mm 2 adet

TC 563.16 Ekleme parçası 101 mm 2 adet

TC 563.17 Ekleme parçası 152 mm 2 adet

TC 563.18 Ekleme parçası 203 mm 2 adet



TC 563.19 400 x 460 mm
Ayarlanabilir çember



TC 563.20 310 x 460 mm
Ayarlanabilir çember



MEYERDING
TC 569.00 17 x 60 mm
TC 569.01 25 x 85 mm
TC 569.02 50 x 95 mm



Rektum ekartörü
TC 569.03 75 mm
TC 569.04 100 mm

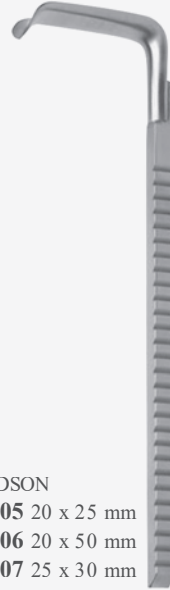

RICHARDSON
TC 569.05 20 x 25 mm
TC 569.06 20 x 50 mm
TC 569.07 25 x 30 mm



MAYO
TC 569.08 30 x 30 mm
TC 569.09 50 x 50 mm



KELLY
TC 570.00 51 x 64 mm
TC 570.01 51 x 75 mm
TC 570.02 64 x 76 mm
TC 570.03 53 x 102 mm
TC 570.04 53 x 127 mm
TC 570.05 53 x 150 mm

TC 570.06 25 x 40 mm
TC 570.07 25 x 50 mm
TC 570.08 50 x 40 mm
TC 570.09 50 x 200 mm

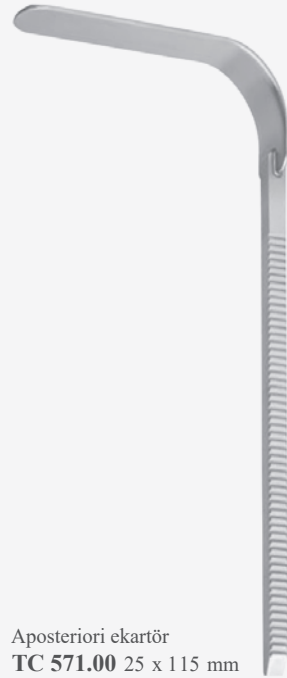

Aposteriori ekartör
TC 571.00 25 x 115 mm

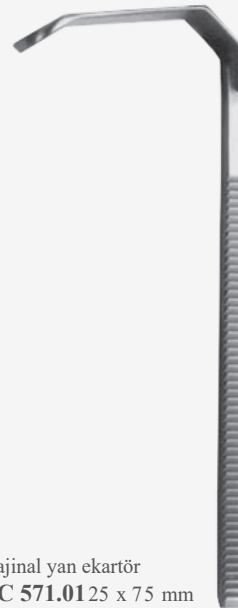

Vajinal yan ekartör
TC 571.01 25 x 75 mm

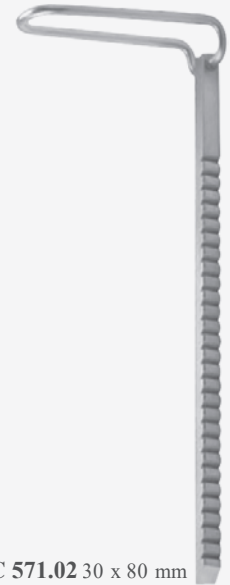

TC 571.02 30 x 80 mm



- TC 572.00 20 x 50 mm
- TC 572.01 20 x 75 mm
- TC 572.02 25 x 25 mm
- TC 572.03 25 x 100 mm
- TC 572.04 25 x 125 mm
- TC 572.05 40 x 75 mm
- TC 572.06 40 x 100 mm
- TC 572.07 40 x 150 mm
- TC 572.08 40 x 200 mm
- TC 572.09 50 x 150 mm
- TC 572.10 50 x 200 mm
- TC 572.11 50 x 250 mm
- TC 572.12 75 x 150 mm
- TC 572.13 75 x 200 mm
- TC 572.14 75 x 250 mm
- TC 572.15 75 x 300 mm
- TC 572.16 100 x 200 mm
- TC 572.17 100 x 250 mm
- TC 572.18 100 x 300 mm

Bükülebilir



- TC 572.19 50 x 230 mm
- TC 572.20 75 x 230 mm

Bükülebilir



- YU-HOLTGREWE
- TC 573.00 60 x 150 mm

Bükülebilir

- TC 574.00 40 x 150 mm
- TC 574.01 50 x 150 mm
- TC 574.02 75 x 150 mm

Bükülebilir



- TC 574.03 40 x 200 mm
- TC 574.04 50 x 250 mm
- TC 574.05 75 x 250 mm
- TC 574.06 75 x 300 mm
- TC 574.07 100 x 200 mm
- TC 574.08 100 x 250 mm
- TC 574.09 100 x 300 mm

Bükülebilir





BALFOUR
TC 564.00 75 x 60 mm
TC 564.01 75 x 80 mm
TC 564.02 75 x 90 mm

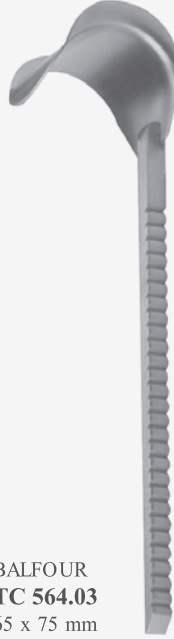

BALFOUR
TC 564.03
65 x 75 mm



HARRINGTON
TC 565.00 40 x 145 mm
TC 565.01 65 x 145 mm
TC 565.02 60 x 140 mm
TC 565.03 90 x 250 mm
TC 565.04 110 x 250 mm



ST. MARKS
TC 566.00 60 x 190 mm



DEAVER
TC 567.00 25 x 110 mm
TC 567.01 40 x 110 mm
TC 567.02 50 x 110 mm



MAGRINA
TC 568.00 25 x 90 mm
TC 568.01 25 x 130 mm



TC 575.00
17 x 20 mm



TC 575.01
20 x 8.5 mm



TC 575.02
25 x 8.5 mm

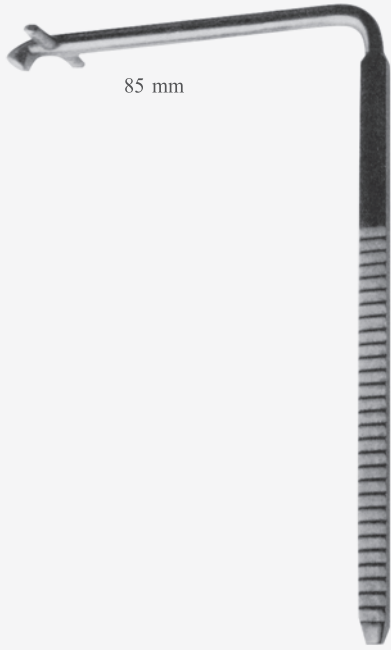

85 mm

SCOVILLE
TC 576.00



50 mm

SCOVILLE
TC 576.01



GELPI
TC 576.02

NOT:



NOT:



NOT:





TEKNO-CER

CERRAHİ ALETLER İMALAT SAN. ve TİC. LTD. ŞTİ.

📍 Yenimahalle Mah. 7. Sokak No:26 Canik/SAMSUN

☎ +90(362) 228 63 39 📠 +90(362) 228 09 90

📱 +90(546) 640 05 55

✉ info@teknocer.com.tr

🏠 www.teknocer.com.tr